

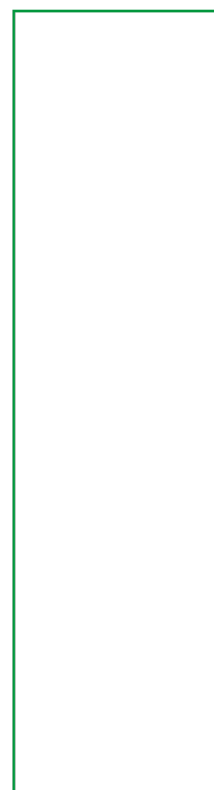

LED COMPONENTS
LED MODULES

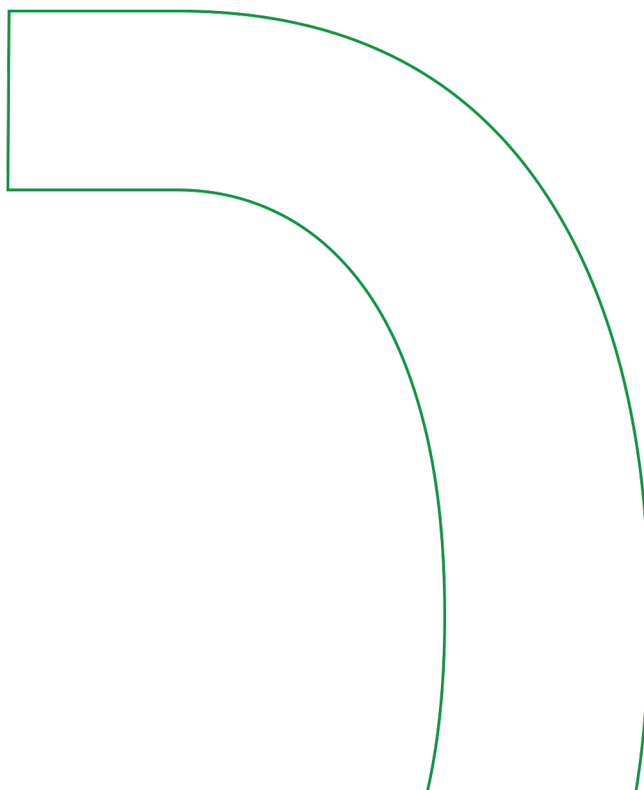

LED MODULE Ø 17 MM MAX. 960MA 3000K CRI>90 10X LED LUMINUS CUBE 1616

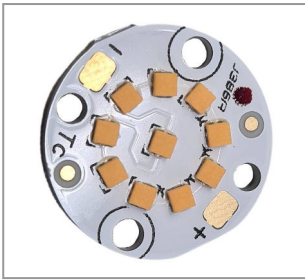

Product number	1100-0017-0960-9300	
Height	2.8mm	beam angle: 170 degrees
Number of poles:	2	Color 3.000K
Channels:	1	temperature:
Solder pad:	Yes	Board material: aluminium core
At CC:	850mA	Light output: 960lm
Power supply:	CC	CRI: >90
Power consumption:	9W	Weight: 1g
Outer diameter: 17,0mm		Surface and color: white
		IP Schutzart: IP20

LED MODULE Ø 17 MM MAX. 960MA 3000K CRI>90 10X LED LUMINUS CUBE 1616 WITH CABLE BLACK AND RED 1000 MM



Product number	1100-0017-0960-9309		
Height	2.7mm	Power 9W	Board material: aluminium core
Number of poles:	2	consumption:	Light output: 960lm
Channels:	1	Outer diameter: 17,0mm	CRI: >90
Solder pad:	Yes	Cable type: single strand	Weight: 1g
At CC:	960mA	Cable length: 150mm	Cable cross section: 0,5mm ²
Number of wires:	2	Cable FEP	Surface and color: white
Cable end processing:	tinned	conversion:	IP Schutzart: IP20
Power supply:	CC	beam angle: 170 degrees	
		Color 3.000K	
		temperature:	
		Material: Aluminium	

LED-MODUL Ø 17 MM MAX. 1000MA 2700K CRI>90 10X LED LUMINUS CUBE 1616 EPREL 880798

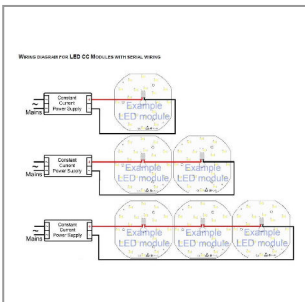

Product number	1100-0017-1000-9270		
Height	2.8mm	Power 9W	At CC: 1000mA
Screw-on:	Yes	consumption:	Material: Aluminium
Number of poles:	2	Color 2.700K	Board material: aluminium core
Channels:	1	temperature:	Light output: 960lm
Solder pad:	Yes	Outer diameter: 17,0mm	Weight: 1g
Number of wires:	2	CRI: >93	Cable cross section: 0,5mm ²
Cable end processing:	tinned	Cable type: single strand	Surface and color: white
Power supply:	CC	Cable length: 150mm	IP Schutzart: IP20
		Cable FEP	
		conversion:	
		beam angle: 170 degrees	

LED MODULE Ø 17 MM MAX. 1000MA 2700K CRI>90 10X LED LUMINUS CUBE 1616 WITH CABLE BLACK AND RED 2000 MM



Product number	1100-0017-1000-9278		
Height	2.8mm	Color 2.700K	Board material: aluminium core
Number of poles:	2	temperature:	Light output: 960lm
Channels:	1	Outer diameter: 17,0mm	CRI: >90
Solder pad:	Yes	Cable type: single strand	Weight: 1g
Number of wires:	2	Cable FEP	Cable cross section: 0,5mm ²
Cable end processing:	tinned	conversion:	Surface and color: white
Power supply:	CC	beam angle: 170 degrees	IP Schutzart: IP20
Power consumption:	9W	At CC: 1000mA	
		Cable length: 2000mm	
		Material: Aluminium	

LED MODULE Ø17 MM MAX. 1000MA 2700K CRI>90 10X LED LUMINUS CUBE 1616 WITH CABLE BLACK AND RED 150 MM

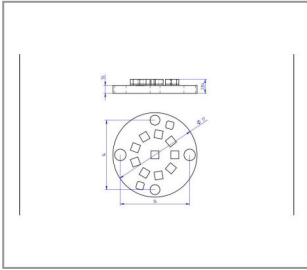

Product number 1100-0017-1000-9279

Color 2.700K
 temperature:
 Outer diameter: 17,0mm
 Cable length: 150mm
 At CC: 1000mA
 Board material: aluminium core
 CRI: >90
 IP Schutzart: IP20

LED MODULE Ø17 MM MAX. 1000MA 2700K CRI>90 10X LED LUMINUS CUBE 1616 WITH CABLE BLACK AND RED 150 MM



Product number 1100-0017-1000-9279R

LED-MODUL Ø 35 MM MAX. 1400MA 2700K CRI> 90 35X LED LUMINUS CUBE 1919



Product number 1100-0035-1400-9270

Height	4mm	CRI:	>93
Screw-on:	Yes	beam angle:	180 degrees
Number of poles:	2	At CC:	1400mA
Channels:	1	Material:	Aluminium
Solder pad:	Yes	Board material:	aluminium core
Power supply:	CC	Surface and color:	white
Color	2.700K	IP Schutzart:	IP20
temperature:			
Outer diameter:	35,0mm		

LED-MODUL Ø 35 MM MAX. 1400MA 2700K CRI> 90 35X LED LUMINUS CUBE 1919 M. KABEL SCHWARZ U. ROT 150 MM

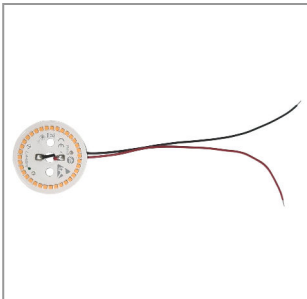

Product number 1100-0035-1400-9279

Height	5mm	Color	2.700K	Light output:	3900lm
Screw-on:	Yes	temperature:		Material:	Aluminium
Number of poles:	2	Outer diameter:	35,0mm	Board material:	aluminium core
Channels:	1	Cable type:	single strand	CRI:	>90
Solder pad:	Yes	Cable length:	150mm	Surface and color:	white
Number of wires:	2	Cable cross section:	0,34mm ²	IP Schutzart:	IP20
Cable end processing:	tinned	beam angle:	170 degrees		
Power supply:	CC	Weight:	4,9g		
		At CC:	1400mA		

LED MODULE ?? 60 MM 24V/DC 2700K CRI>90 WITH PROXY SWITCH AND ERNI CLAMPS, SCOTCH 3M ADHESIVE PAD ON THE BACK



Product number

1100-0060-0024-9270

Height: 5mm
Screw-on: Yes
Number of poles: 2
Channels: 1
Plug contact: Yes
Color: 2.700K
temperature:
Weight: 9,15g
Outer diameter: 60,0mm

At CV: 24
beam angle: 170 degrees
Light output: 1450lm
Material: Aluminium
Board material: aluminium core
CRI: >90
Surface and color: white
IP Schutzart: IP20

LED-MODUL ?? 70 MM MAX. 1000MA 2700K CRI> 90 M. ADELS-KLEMME



Product number

1100-0070-1000-9270

Height: 4mm
Screw-on: Yes
Number of poles: 2
Channels: 1
Plug contact: Yes
Power supply: CC
Color: 2.700K
temperature:
Outer diameter: 70,0mm

Light output: 900lm
beam angle: 170 degrees
Weight: 11,29g
At CC: 1000mA
Material: Aluminium
Board material: aluminium core
CRI: >90
Surface and color: white

IP Schutzart: IP20

LED MODULE ??80 MM 24V/DC 8W 1,080LM 2,700K CRI>90 ALUPCB



Product number

1100-0080-1080-9270

Screw-on: Yes
Number of poles: 2
Channels: 1
Plug contact: Yes
Anzahl Linsen: 16Stk
Outer diameter: 80,0mm
Color: 2.700K
temperature:
Power supply: CV
At CC: 330mA

Weight: 21,3g
Linsentyp: Multilinsen
Material: Aluminium
Power: 8W
consumption:
Board material: aluminium core
CRI: >90

LED-MODUL ?? 140 MM MAX. 640MA 3000K CRI>80

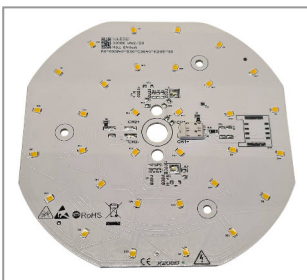

Product number

1100-0140-0640-8300

Height: 4mm
Screw-on: Yes
Number of poles: 2
Channels: 1
Plug contact: Yes
Board material: FR4
Power supply: CC
Outer diameter: 140,0mm

beam angle: 120 degrees
Weight: 99g
At CC: 640mA
Color: 3.000K
temperature:
Light output: 1400lm
CRI: >90
Surface and color: white
IP Schutzart: IP20

LED MODULE ?? 170 MM 230V/AC 16W 3000K CRI>85 1600LM ALUPCB 42X LED SSC 5630HV WHITE

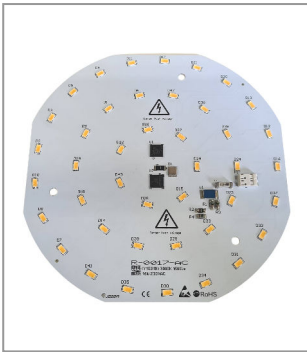

Product number

Height: 5mm
Screw-on: Yes
Number of poles: 2
Weight: 90g
Number of wires: 2
Cable conversion: PVC
Surface: PUR-Polyurethan
Cable end processing: ferrule

1100-0170-0230-8300

CRI: >85
Cable cross section: 0,75mm??
beam angle: 120 degrees
Outer diameter: 170,0mm
Power supply: AC - 230V
Color: 3.000K
temperature: Aluminium
IP Schutzart: IP44

Light output: 1760lm
Power consumption: 16W
Board material: aluminium core
Cable length: 120mm
Cable type: twin strands
Surface and color: white

LED-MODUL ?? 170 MM MAX. 825MA 3000K CRI>85 35X LED OSRAM DURIS E5 M. WAGO 2060 WEISS

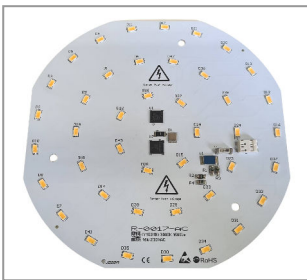

Product number

Height: 4mm
Screw-on: Yes
Number of poles: 2
Channels: 1
Plug contact: Yes
Weight: 90g
Board material: FR4
Power supply: CC

1100-0170-0825-8300

CRI: >85
beam angle: 120 degrees
Outer diameter: 170,0mm
Color: 3.000K
temperature: 825mA
Light output: 1900lm
Material: Aluminium
Surface and color: white

IP Schutzart: IP20

LED MODULE ?? 180 MM MAX. 1530MA 2700K CRI>90 LED LUMINUS 2016

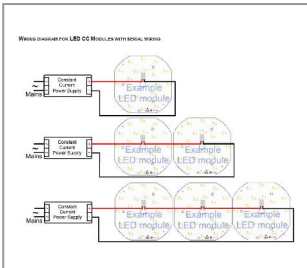

Product number

Height: 4mm
Screw-on: Yes
Number of poles: 2
Channels: 1
Plug contact: Yes
At CC: 1530mA
Diameter inside: 10,0mm
Board material: FR4

1100-0180-1530-9270

Power supply: CC
Color: 2.700K
temperature: >93
beam angle: 120 degrees
Outer diameter: 180,0mm
IP Schutzart: IP20

LED MODULE ?? 230 MM MAX. 1155MA 3000K CRI>85 49X LED OSRAM DURIS E5 WITH WAGO 2060 WHITE



Product number

Height: 4mm
Screw-on: Yes
Number of poles: 2
Channels: 1
Plug contact: Yes
Board material: FR4
At CC: 1155mA
Light output: 3100lm

1100-0230-1155-8300

Power supply: CC
Outer diameter: 230,0mm
CRI: >85
Weight: 110g
beam angle: 120 degrees
Color: 3.000K
temperature: white
Surface and color: white
IP Schutzart: IP20

LED MODULE ??240 MM 24V/DC 18W 1,920LM 2700K CRI>90

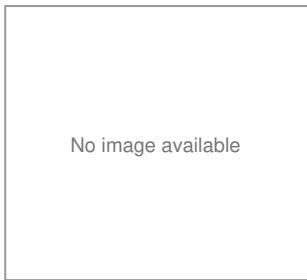

Product number 1100-0240-1824-9270

Power supply: CC
 Power 18W
 consumption:
 Color 2.700K
 temperature:
 Diameter inside: 240,0mm
 At CV: 24
 Light output: 1920lm
 Board material: aluminium core
 CRI: >90

LED-MODUL ?? 260 MM MAX. 1680MA 3000K CRI>85

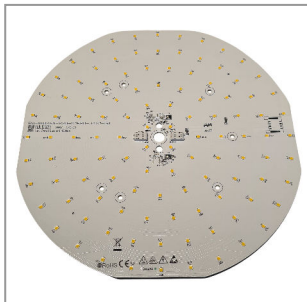

Product number 1100-0260-1680-8300

Height 4mm
 Screw-on: Yes
 Number of 2
 poles:
 Channels: 1
 Plug contact: Yes
 Board material: FR4
 Weight: 118g
 Power supply: CC
 CRI: >85
 beam angle: 120 degrees
 Color 3.000K
 temperature:
 At CC: 1680mA
 Light output: 5160lm
 Outer diameter: 260,0mm
 Power 41W
 consumption:
 Surface and white
 color:

IP Schutzart: IP20

LED-MODUL ?? 260 MM MAX. 1680MA 3500K CRI>85



Product number 1100-0260-1680-8350

Height 4mm
 Screw-on: Yes
 Number of 2
 poles:
 Channels: 1
 Plug contact: Yes
 Board material: FR4
 Color 3.500K
 temperature:
 Power supply: CC
 Light output: 5200lm
 CRI: >85
 beam angle: 120 degrees
 Weight: 119g
 At CC: 1680mA
 Outer diameter: 260,0mm
 Power 41W
 consumption:
 Surface and white
 color:

IP Schutzart: IP20

LED-MODUL ?? 320 MM MAX. 1530MA 3500K CRI>85

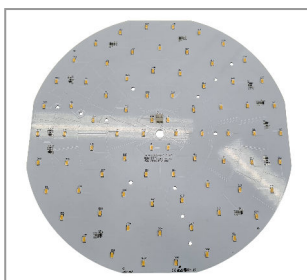

Product number 1100-0320-1530-8350

Height 4mm
 Screw-on: Yes
 Number of 2
 poles:
 Channels: 1
 Plug contact: Yes
 At CC: 1530mA
 Board material: FR4
 Color 3.500K
 temperature:
 Power supply: CC
 CRI: >85
 Outer diameter: 320,0mm
 beam angle: 120 degrees
 Weight: 135g
 Power 49W
 consumption:
 Light output: 6100lm
 Surface and white
 color:

IP Schutzart: IP20

LED-MODUL ?? 320 MM MAX. 1530MA 3000K CRI>93

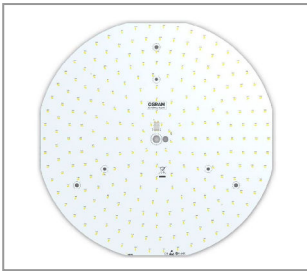

Product number	1100-0320-1530-9300	
Height	4mm	Outer diameter: 320,0mm
Screw-on:	Yes	CRI: >93
Number of poles:	2	beam angle: 120 degrees
Channels:	1	Color 3.000K
Plug contact:	Yes	temperature:
At CC:	1530mA	Surface and color: white
Diameter inside:	10,0mm	IP Schutzart: IP20
Board material:	FR4	

LED-MODUL ?? 400 MM MAX. 1530MA 3000K CRI>85

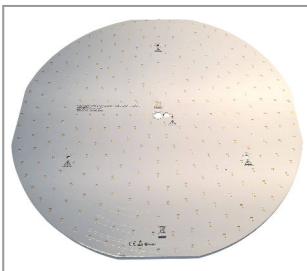

Product number	1100-0400-1530-8300	
Screw-on:	Yes	beam angle: 120 degrees
Number of poles:	2	Color 3.000K
Channels:	1	temperature:
Plug contact:	Yes	Light output: 6100lm
At CC:	1530mA	Power 41W
Board material:	FR4	consumption:
Power supply:	CC	Surface and color: white
CRI:	>85	IP Schutzart: IP20

LED-MODUL ?? 45 MM 230V/AC 8W 3000K CRI>85 800LM M. KABEL 280 MM VERGOSSEN M. REDUKTION F. REFLEKTOR



Product number	1101-0045-0230-8307	
Height	8mm	CRI: >85
Screw-on:	Yes	Light output: 440lm
Number of poles:	2	Outer diameter: 45,0mm
Channels:	1	Cable length: 280mm
Number of wires:	2	Cable cross section: 0,75mm??
Weight:	32g	beam angle: 120 degrees
Surface:	PUR- Polyurethan	Power supply: AC - 230V
Cable end processing:	ferrule	Power 4W
		consumption:
		Color 3.000K
		temperature:
		IP Schutzart: IP44
		Cable conversion: PTFE
		Board material: aluminium core
		Cable type: twin strands
		Surface and color: white

LED MODULE ?? 60 MM 24V/DC 2700K CRI>90 WITH 1.300MM CABLE BLACK/RED BACK SCOTCH 3M ADHESIVE PAD

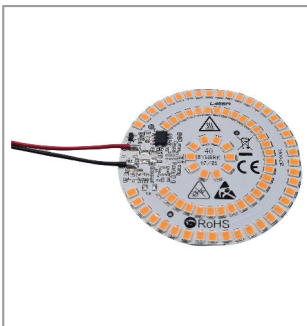

Product number	1101-0060-0024-9270	
Height	3mm	Power 10W
Number of poles:	2	consumption:
Channels:	1	Light output: 1200lm
Solder pad:	Yes	Weight: 10g
Number of wires:	2	Cable type: single strand
Cable end processing:	tinned	Outer diameter: 60,0mm
Color	2.700K	At CV: 24
temperature:		Cable FEP
Power supply:	CV	conversion:
		beam angle: 120 degrees
		Cable length: 1300mm
		Material: Aluminium
		Board material: aluminium core
		CRI: >90
		Cable cross section: 0,5mm??
		Surface and color: white
		IP Schutzart: IP20

LED MODULE Ø 80 MM 230V/AC 4W 3000K CRI>85 400LM ALUPCB WHITE 12X LED SSC 5630HV POTTED



Product number

1101-0080-0230-8300

Height	8mm	CRI:	>85	Power	4W
Screw-on:	Yes	Light output:	440lm	consumption:	
Number of poles:	2	Cable length:	280mm	Color	3.000K
Channels:	1	Cable conversion:	FEP	temperature:	
Number of wires:	2	Cable cross section:	0,75mm ²	IP Schutzart:	IP44
Outer diameter:	80,0mm	beam angle:	120 degrees	Board material:	aluminium core
Surface:	PUR-Polyurethan	Weight:	49g	Cable type:	twin strands
Cable end processing:	ferrule	Power supply:	AC - 230V	Surface and color:	white

LED-MODUL Ø 80 MM 230V/AC 12W 3000K CRI>85 1200LM ALUPCB VERGOSSEN M. KABEL 280 MM U. BAJONETT F. LEDIL ANGELA M



Product number

1101-0080-0230-8306

Height	8mm	Surface:	PUR-Polyurethan	Color	3.000K
Screw-on:	Yes	Cable end processing:	ferrule	temperature:	
Number of poles:	2	CRI:	>85	Material:	Aluminium
Channels:	1	Light output:	1200lm	IP Schutzart:	IP44
Number of wires:	2	Cable length:	280mm	Board material:	aluminium core
Outer diameter:	80,0mm	Cable cross section:	0,75mm ²	Power consumption:	12W
Cable conversion:	PVC	beam angle:	120 degrees	Cable type:	twin strands
Weight:	48g	Power supply:	AC - 230V	Surface and color:	white

LED-MODUL Ø 80 MM 230V/AC 29W 3000K CRI>85 3000LM ALUPCB VERGOSSEN M. KABEL 280 MM U. BAJONETT F. LEDIL ANGELA M



Product number

1101-0080-0230-8309

Height	8mm	Weight:	48g	Power supply:	AC - 230V
Screw-on:	Yes	Surface:	PUR-Polyurethan	Color	3.000K
Number of poles:	2	Cable end processing:	ferrule	temperature:	
Channels:	1	CRI:	>85	Material:	Aluminium
Number of wires:	2	Power consumption:	29W	IP Schutzart:	IP44
Outer diameter:	80,0mm	Cable length:	280mm	Board material:	aluminium core
Light output:	3000lm	Cable cross section:	0,75mm ²	Cable type:	twin strands
Cable conversion:	PVC	beam angle:	120 degrees	Surface and color:	white

LED MODULE Ø 130 MM 230V/AC 8W 3000K CRI>85 800LM ALUPCB POTTED WITH CABLE 250 MM WHITE



Product number

1101-0130-0230-8300

Height	8mm	Cable end processing:	ferrule	Outer diameter:	130,0mm
Screw-on:	Yes	CRI:	>85	Material:	Aluminium
Number of poles:	2	Cable length:	280mm	IP Schutzart:	IP44
Channels:	1	Cable cross section:	0,75mm ²	Power	8W
Number of wires:	2	beam angle:	120 degrees	consumption:	
Light output:	880lm	Power supply:	AC - 230V	Board material:	aluminium core
Cable conversion:	PVC	Color	3.000K	Cable type:	twin strands
Surface:	PUR-Polyurethan	temperature:		Surface and color:	white
		Weight:	135g		

LED MODULE Ø 170 MM 230V/AC 8W 3000K CRI>85 880LM ALUPCB WHITE 42X LED SSC 5630HV POTTED

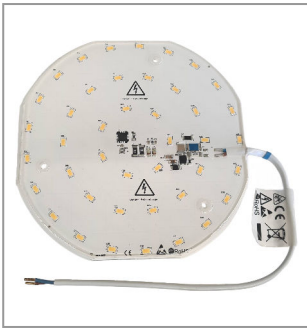

Product number

Height 8mm
Screw-on: Yes
Number of poles: 2
Channels: 1
Number of wires: 2
Light output: 880lm
Cable conversion: PVC
Surface: PUR-Polyurethan

1101-0170-0230-8307

Cable end processing: ferrule
CRI: >85
Weight: 212g
Cable length: 280mm
Cable cross section: 0,75mm²
beam angle: 120 degrees
Outer diameter: 170,0mm
Power supply: AC - 230V

Color 3.000K
temperature: aluminium
Material: IP44
IP Schutzart: 8W
Power consumption: aluminium core
Board material: twin strands
Cable type: white
Surface and color:

LED MODULE Ø 170 MM 230V/AC 16W 3000K CRI>85 1600LM ALUPCB WHITE 42X LED SSC 5630HV POTTED

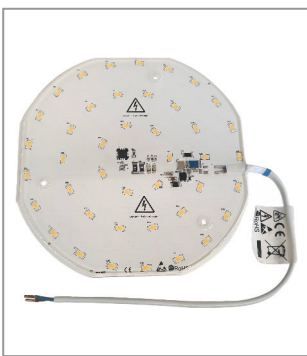

Product number

Height 8mm
Screw-on: Yes
Number of poles: 2
Number of wires: 2
Cable conversion: PVC
Surface: PUR-Polyurethan
Cable end processing: ferrule
CRI: >85

1101-0170-0230-8308

Weight: 212g
Light output: 1600lm
Cable length: 280mm
Cable cross section: 0,75mm²
beam angle: 120 degrees
Outer diameter: 170,0mm
Power supply: AC - 230V
Color 3.000K
temperature:

Material: Aluminium
IP Schutzart: IP44
Power 16W
consumption: aluminium core
Board material: twin strands
Cable type: white
Surface and color:

LED MODULE POTTED Ø45 MM 230V/AC 8W 3000K CRI>80 962LM WITH CABLE 2X0.75 FLAT P/P 280 MM

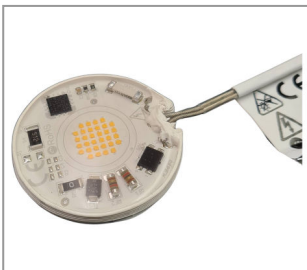

Product number

Height 5.5mm
Weight: 20,55g
Outer diameter: 45,0mm
CRI: >80
Cable length: 280mm
Light output: 962lm
Power supply: AC - 230V
Surface: Spotted

1111-0045-0230-8300

Color 3.000K
temperature: Aluminium
Material: 8W
Power consumption: aluminium core
Board material:

LED MODULE Ø115 MM 185-265V/AC 12W 3000K ALUPCB 24X LED 2835 INCLUDING OPTICS AND CABLE

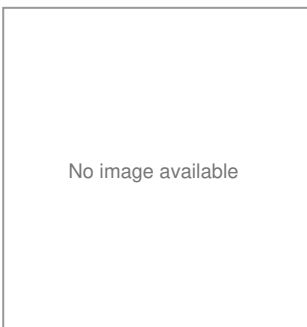

No image available

Product number

Height 10mm
Screw-on: Yes
Number of poles: 2
Channels: 1
Board material: FR4
Number of wires: 2
Cable conversion: PVC
Cable end processing: ferrule

1125-0115-0265-8300

Light output: 1200lm
beam angle: 45 degrees
Weight: 10g
CRI: >80
Cable cross section: 0,75mm²
Outer diameter: 115,0mm
Power supply: AC - 230V
Color 3.000K
temperature:

Power 12W
consumption: 110mm
Cable length: twin strands
Cable type: white
Surface and color: Plastic
Material: IP20
IP Schutzart:

LED MODULE Ø170 MM 185-265V/AC 24W 3000K ALUPCB 48X LED 2835 INCLUDING OPTICS AND CABLE

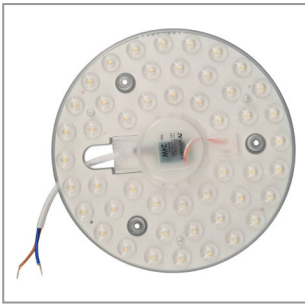

Product number

Height 10mm
Screw-on: Yes
Number of poles: 2
Channels: 1
Board material: FR4
Number of wires: 2
Light output: 2400lm
Cable conversion: PVC

1125-0170-0265-8300

Cable end processing: ferrule
beam angle: 45 degrees
CRI: >80
Cable cross section: 0,75mm²
Outer diameter: 170,0mm
Weight: 15g
Power supply: AC - 230V
Color: 3.000K
temperature:

Power consumption: 24W
Cable length: 110mm
Cable type: twin strands
Surface and color: white
Material: Plastic
IP Schutzart: IP20

LED MODULE Ø230 MM 185-265V/AC 36W 3000K ALUPCB 72X LED 2835 INCLUDING OPTICS AND CABLE

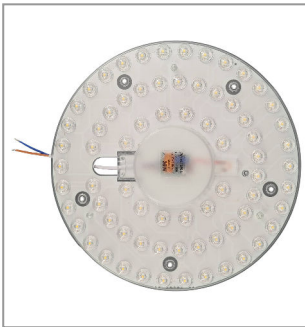

Product number

Height 10mm
Screw-on: Yes
Number of poles: 2
Channels: 1
Board material: FR4
Number of wires: 2
Light output: 3600lm
Outer diameter: 230,0mm

1125-0230-0265-8300

Cable conversion: PVC
Cable end processing: ferrule
beam angle: 45 degrees
CRI: >80
Cable cross section: 0,75mm²
Power supply: AC - 230V
Color: 3.000K
temperature:
Weight: 20g

Power consumption: 36W
Cable length: 110mm
Cable type: twin strands
Surface and color: white
Material: Plastic
IP Schutzart: IP20

LED MODULE Ø230 MM 185-265V/AC 36W 4000K ALUPCB 72X LED 2835 INCLUDING OPTICS AND CABLE

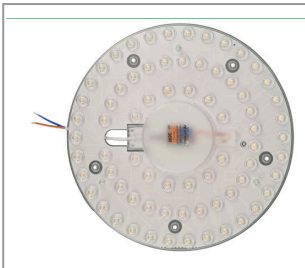

Product number

Power supply: AC - 230V
Color: 4.000K
temperature:

1125-0230-0265-8400

LED MODULE WITH MAGNETIC FASTENING Ø230 MM 185-265V/AC 36W 4000K ALUPCB 72X LED 2835 INCLUDING OPTICS AND CABLE

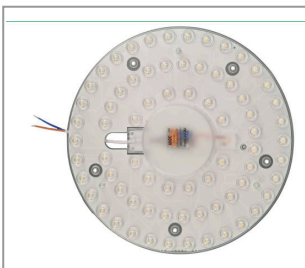

Product number

1125-0230-0265-8401

LED MODULE ?? 200 MM FITTED ON BOTH SIDES WITH LED CROWN AND DIMMER CONTROL 24V/DC 34W 2700K CRI>85 3800LM BIN B7V

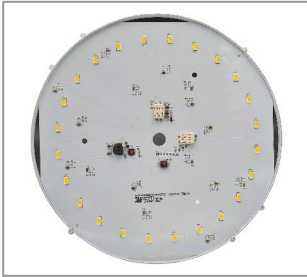

Product number 1165-0200-0024-8270

Board material: FR4	Light output: 3800lm
beam angle: 360 degrees	IP Schutzart: IP20
Color 2.700K	
temperature:	
Power supply: CV	
CRI: >85	
Power 34W	
consumption:	
At CV: 24	
Outer diameter: 200,0mm	

LED MODULE ?? 200 MM FITTED ON BOTH SIDES WITH LED RING AND DIMMER CONTROL 24V/DC 34W 2700K CRI>85 3800LM NEW GENERATION

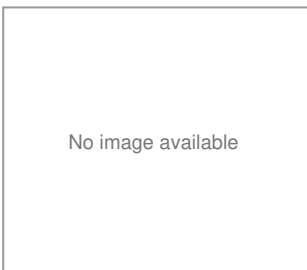

Product number 1165-0200-0024-8271

LED MODULE ?? 200 MM FITTED ON BOTH SIDES WITH LED RING AND DIMMER CONTROL 24V/DC 34W 3000K CRI>85 4100LM



Product number 1165-0200-0024-8300

Height 10mm	beam angle: 360 degrees	Color 3.000K
Screw-on: Yes	Light output: 4200lm	temperature:
Number of poles: 2	Power supply: CV	Surface and white
Channels: 1	CRI: >85	color:
Plug contact: Yes	Power 34W	IP Schutzart: IP20
Diameter inside: 10,0mm	consumption:	
Board material: FR4	At CV: 24	
Control: Yes	Weight: 72g	
	Outer diameter: 200,0mm	

LED-RINGMODUL Ø63 MM MAX 160MA 36V @120MA 4,5W 600LM 3000K CRI>90 F. BLACKLINE CIRCLE Ø70MM

Product number 1500-0063-0160-9300

Outer diameter: 63,0mm
 Cooling 0W
 capacity:
 Color 3.000K
 temperature:
 CRI: >90
 Weight: 7,2g
 Light output: 600lm

LED RING MODULE Ø108 MM MAX 320MA 36V @240MA 9W 1200LM 3000K CRI>90 FOR BLACKLINE CIRCLE

Product number 1500-0108-0320-9300

Light output: 1200lm
 Weight: 14,5g
 Color 3.000K
 temperature:
 Outer diameter: 108,0mm
 CRI: >90

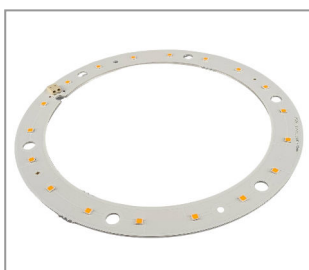
LED-RINGMODUL Ø153 MM MAX 480MA 36V @360MA 13,5W 1800LM 3000K CRI>90 F. BLACKLINE CIRCLE Ø160MM

Product number 1500-0153-0480-9300

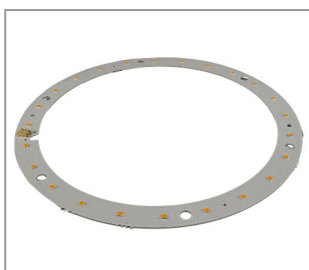
Weight: 22g
 Light output: 1800lm
 Outer diameter: 153,0mm
 Color 3.000K
 temperature:
 CRI: >90

LED-RINGMODUL Ø198 MM MAX 640MA 36V @500MA 18W 2400LM 3000K CRI>90 F. BLACKLINE CIRCLE Ø205MM

Product number 1500-0198-0640-9300

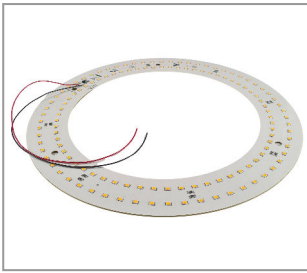
Light output: 2400lm
 Outer diameter: 198,0mm
 Color 3.000K
 temperature:
 CRI: >90

LED MODULE Ø 280 MM 24V/DC 16W 3000K CRI>85 1680LM ALUPCB WITH WHITE PROTECTIVE COATING



Product number 1501-0280-0024-8301

Outer diameter: 280,0mm
CRI: >85
Light output: 1680lm
Color temperature: 3.000K

LED-MODUL Ø 280 MM 230V/AC 16W 3000K CRI>85 1680LM ALUPCB 126X LED SSC VERGOSSEN WEISS

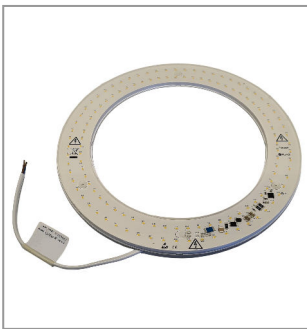

Product number 1501-0280-0230-8300

Height 8mm
Screw-on: Yes
Number of poles: 2
Channels: 1
Outer diameter: 280,0mm
Number of wires: 2
Cable conversion: PVC
Surface: PUR-Polyurethan

Cable end processing: ferrule
CRI: >85
Light output: 1600lm
Cable length: 280mm
Cable cross section: 0,75mm²
beam angle: 120 degrees
Diameter inside: 200,0mm
Weight: 300g

Power supply: AC - 230V
Color temperature: 3.000K
Material: Aluminium
IP Schutzart: IP44
Power consumption: 16W
Board material: aluminium core
Cable type: twin strands
Surface and color: white

LED-MODUL Ø 280 MM 230V/AC 16W 4000K CRI>85 1680LM ALUPCB 126X LED SSC VERGOSSEN WEISS



Product number 1501-0280-0230-8400

Height 8mm
Width 230mm
Länge: 230mm
Screw-on: Yes
Number of poles: 2
Channels: 1
Number of wires: 2
Cable conversion: PVC

Surface: PUR-Polyurethan
Cable end processing: ferrule
Power consumption: 20W
CRI: >85
Cable length: 280mm
Cable cross section: 0,75mm²
beam angle: 120 degrees
Power supply: AC - 230V

Light output: 2200lm
IP Schutzart: IP44
Color temperature: 4.000K
Board material: aluminium core
Weight: 217g
Cable type: twin strands

LED MODULE Ø 380 MM 24V/DC 30W 3000K CRI>85 3300LM ALUPCB POTTED WHITE

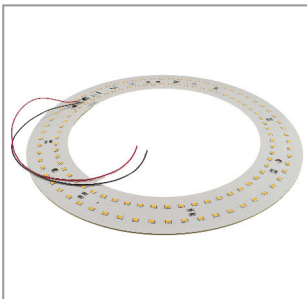

Product number 1501-0380-0024-8300

Height 1.6mm
Screw-on: Yes
Outer diameter: 380,0mm
Number of poles: 2
Channels: 1
Board material: FR4
Number of wires: 2
Surface: Painted

Light output: 3000lm
Cable conversion: PVC
Power supply: CV
Cable end processing: ferrule
CRI: >85
At CV: 24
Cable length: 280mm
Cable cross section: 0,75mm²

beam angle: 120 degrees
Power consumption: 30W
Color temperature: 3.000K
Weight: 374g
IP Schutzart: IP44
Diameter inside: 300,0mm
Cable type: twin strands
Surface and color: white

LED-MODUL Ø 380 MM 24V/DC 30W 3000K CRI>85 3300LM FR4 SCHUTZLACK WEISS

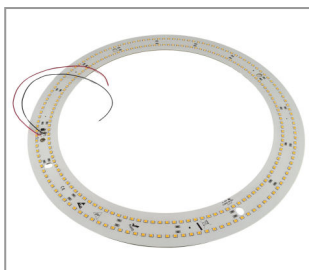

Product number 1501-0380-0024-8301
 Outer diameter: 380,0mm
 CRI: >85
 Light output: 3300lm
 Color: 3.000K
 temperature:

LED-MODUL 480X200 MM 230V/AC 28,8W 3000K CRI>85 4480LM ALUPCB VERGOSSEN WEISS

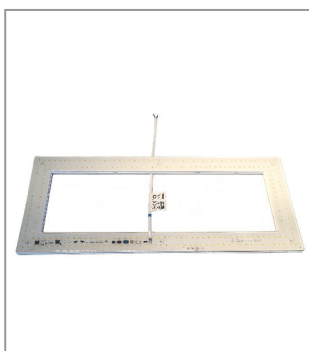

Product number	1501-0480-0230-8300		
Height	8mm	Cable	PVC
Width	200mm	conversion:	
Länge:	480mm	Surface:	PUR-
Screw-on:	Yes		Polyurethan
Number of poles:	2	Cable end processing:	ferrule
Channels:	1	CRI:	>85
Number of wires:	2	Power consumption:	29W
Light output:	3000lm	Cable length:	280mm
		Cable cross section:	0,75mm ²
		beam angle:	120 degrees

Power supply:	AC - 230V
Weight:	425g
Color:	3.000K
temperature:	
Material:	Aluminium
IP Schutzart:	IP44
Board material:	aluminium core
Cable type:	twin strands
Surface and color:	white

LED MODULE 150X150 MM 24V/DC 13W 3000K CRI>85 1297LM

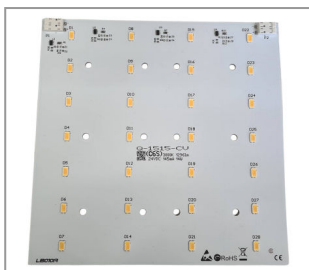

Product number	1200-0150-0024-8300		
Height	4mm	Board material:	FR4
Width	150mm	Power supply:	CV
Length:	150mm	CRI:	>85
Screw-on:	Yes	Light output:	1300lm
Number of poles:	2	At CV:	24
Channels:	1	beam angle:	120 degrees
Plug contact:	Yes	Power consumption:	13W
Diameter inside:	10,0mm	Weight:	81g
		Color temperature:	3.000K
		Surface and color:	white
		IP Schutzart:	IP20

LED MODULE 150X150 MM 24V/DC 13W 3000K CRI>85 1297LM WITH ML

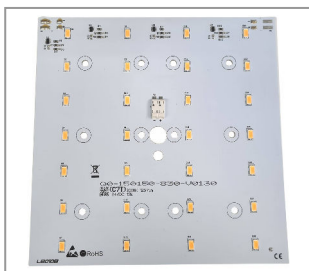

Product number	1200-0150-0024-8302		
Height	4mm	Board material:	FR4
Width	150mm	Power supply:	CV
Length:	150mm	CRI:	>85
Screw-on:	Yes	Light output:	1300lm
Number of poles:	2	At CV:	24
Channels:	1	beam angle:	120 degrees
Plug contact:	Yes	Power consumption:	13W
Diameter inside:	10,0mm	Weight:	78g
		Color temperature:	3.000K
		Surface and color:	white
		IP Schutzart:	IP20

LED MODULE 150X150 MM MAX. 660MA 3000K CRI>85



Product number	1200-0150-0660-8300		
Height	4mm	Board material:	FR4
Width	150mm	Power supply:	CC
Length:	150mm	CRI:	>85
Screw-on:	Yes	Light output:	1300lm
Number of poles:	2	beam angle:	120 degrees
Channels:	1	Power consumption:	13W
Plug contact:	Yes	Color temperature:	3.000K
Diameter inside:	10,0mm	Weight:	77g
		Surface and color:	white
		IP Schutzart:	IP20
		At CC:	660mA

LED MODULE 150X150 MM MAX. 1530MA 3000K CRI>90

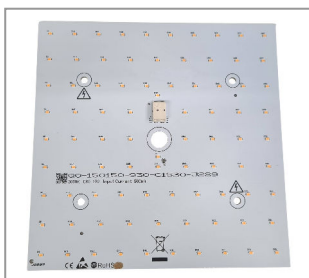

Product number	1200-0150-1530-9300		
Height	4mm	Diameter inside:	10,0mm
Width	150mm	Board material:	FR4
Length:	150mm	Power supply:	CC
Screw-on:	Yes	Power consumption:	26W
Number of poles:	2	CRI:	>93
Channels:	1	beam angle:	120 degrees
Plug contact:	Yes	Light output:	2900lm
At CC:	1530mA	Color temperature:	3.000K
		Weight:	77g
		Surface and color:	white
		IP Schutzart:	IP20

LED MODULE 200X200 MM MAX. 900MA 3000K CRI>85



Product number	1200-0200-0900-8300		
Height	4mm	Board material:	FR4
Width	200mm	Power supply:	CC
L??nge:	200mm	Power	20W
Screw-on:	Yes	consumption:	
Number of	2	CRI:	>85
poles:		Weight:	140g
Channels:	1	beam angle:	120 degrees
Plug contact:	Yes	Light output:	2200lm
Diameter inside:	10,0mm	Color	3.000K
		temperature:	
		At CC:	900mA
		Surface and	white
		color:	
		IP Schutzart:	IP20

LED MODULE 200X200 MM MAX. 1530MA 3000K CRI>90

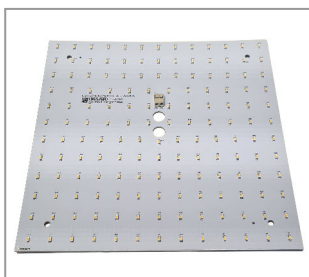

Product number	1200-0200-1530-9300		
Height	4mm	Diameter inside:	10,0mm
Width	200mm	Board material:	FR4
L??nge:	200mm	Light output:	5500lm
Screw-on:	Yes	Power supply:	CC
Number of	2	Weight:	149g
poles:		beam angle:	120 degrees
Channels:	1	Power	48W
Plug contact:	Yes	consumption:	
At CC:	1530mA	Color	3.000K
		temperature:	
		CRI:	>90
		Surface and	white
		color:	
		IP Schutzart:	IP20

LED MODULE 270X270 MM 24V/DC 27W 3000K CRI>85 2600LM



Product number	1200-0270-0024-8309		
Height	4mm	Board material:	FR4
Width	270mm	Power	27W
L??nge:	270mm	consumption:	
Screw-on:	Yes	Power supply:	CV
Number of	2	CRI:	>85
poles:		Weight:	245g
Channels:	1	At CV:	24
Plug contact:	Yes	beam angle:	120 degrees
Diameter inside:	10,0mm	Color	3.000K
		temperature:	
		Light output:	2700lm
		IP Schutzart:	IP20

LED-MODUL 270X270 MM MAX. 1980MA 3000K CRI>85



Product number	1200-0270-1980-8308		
Height	4mm	Board material:	FR4
Width	270mm	Power supply:	CC
L??nge:	270mm	CRI:	>85
Screw-on:	Yes	Light output:	3300lm
Number of	2	Weight:	245g
poles:		beam angle:	120 degrees
Channels:	1	Power	30W
Plug contact:	Yes	consumption:	
Diameter inside:	10,0mm	Color	3.000K
		temperature:	
		At CC:	1980mA
		Surface and	white
		color:	
		IP Schutzart:	IP20

LED-MODUL 110X90 MM 230V/AC 16W 3000K CRI>85 1780LM ALUPCB 33X LED SSC 5630HV VERGOSSEN WEISS



Product number

Height 6mm
Width 90mm
Länge: 110mm
Screw-on: Yes
Number of poles: 2
Channels: 1
Number of wires: 2
Cable PVC
conversion:

1201-0110-0230-8300

Surface: PUR-Polyurethan
Cable end processing: ferrule
Cable length: 280mm
Cable cross section: 0,75mm²
beam angle: 120 degrees
Power supply: AC - 230V
Color 3.000K
temperature:

Material: Aluminium
IP Schutzart: IP44
Power consumption: 16W
Board material: aluminium core
Light output: 1780lm
Surface and color: white

LED MODULE 130X130 MM 230V/AC 8W 3000K CRI>85 1600LM ALUPCB 42X LED SSC 5630HV POTTED WHITE



Product number

Height 8mm
Width 130mm
Länge: 130mm
Number of poles: 2
Channels: 1
Number of wires: 2
Cable PVC
conversion: PUR-Polyurethan
Surface:

1201-0130-0230-8307

Cable end processing: ferrule
Cable length: 280mm
Cable cross section: 0,75mm²
beam angle: 120 degrees
Power supply: AC - 230V
Color 3.000K
temperature: 170g
Weight:

Material: Aluminium
IP Schutzart: IP44
Power consumption: 8W
Board material: aluminium core
Light output: 800lm
Cable type: twin strands
Surface and color: white

LED-MODUL 130X130 MM 230V/AC 16W 3000K CRI>85 1600LM ALUPCB 42X LED SSC 5630HV VERGOSSEN WEISS



Product number

Height 8mm
Width 130mm
Länge: 130mm
Screw-on: Yes
Number of poles: 2
Number of wires: 2
Cable PVC
conversion: PUR-Polyurethan
Surface:

1201-0130-0230-8308

Cable end processing: ferrule
Cable length: 280mm
Cable cross section: 0,75mm²
beam angle: 120 degrees
Power supply: AC - 230V
Color 3.000K
temperature:

Weight: 166g
Material: Aluminium
IP Schutzart: IP44
Power consumption: 16W
Board material: aluminium core
Cable type: twin strands
Surface and color: white

LED MODULE 130X130 MM 230VAC 32W 3000K CRI>85 3560LM ALUPCB 66X LED SSC 5630HV POTTED WHITE



Product number

Height 8mm
Width 130mm
Länge: 130mm
Screw-on: Yes
Number of poles: 2
Channels: 1
Number of wires: 2
Cable PVC
conversion:

1201-0130-0230-8309

Surface: PUR-Polyurethan
Cable end processing: ferrule
Light output: 3560lm
Cable length: 280mm
Cable cross section: 0,75mm²
beam angle: 120 degrees
Power consumption: 32W

Power supply: AC - 230V
Color 3.000K
Weight: 166g
Material: Aluminium
IP Schutzart: IP44
Board material: aluminium core
Cable type: twin strands
Surface and color: white

LED-MODUL 130X130 MM 230V/AC 16W 4000K CRI>85 1600LM ALUPCB 42X LED SSC 5630HV VERGOSSEN WEISS

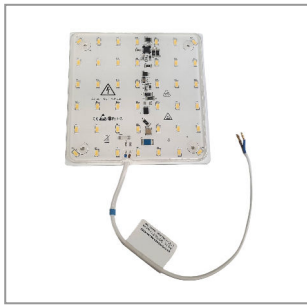

Product number

Height 8mm
Width 130mm
Length: 130mm
Screw-on: Yes
Number of poles: 2
Channels: 1
Number of wires: 2
Cable conversion: PVC

1201-0130-0230-8400

Surface: PUR-Polyurethan
Cable end processing: ferrule
Cable length: 280mm
Cable cross section: 0,75mm??
beam angle: 120 degrees
Power supply: AC - 230V

Weight: 166g
Material: Aluminium
IP Schutzart: IP44
Color: 4.000K
temperature: 4.000K
Power consumption: 16W
Board material: aluminium core
Cable type: twin strands
Surface and color: white

LED-MODUL 200X200 MM 230V/AC 16W 3000K CRI>85 1600LM ALUPCB 39X LED SSC 5630HV VERGOSSEN WEISS

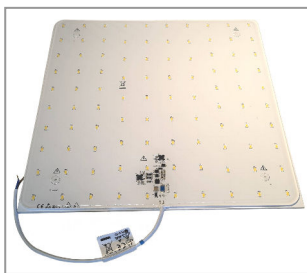

Product number

Width 200mm
Length: 200mm
Screw-on: Yes
Number of poles: 2
Channels: 1
CRI: >85
Light output: 1600lm
Power supply: AC - 230V

1201-0200-0230-8300

Color 3.000K
temperature: 3.000K
Material: Aluminium
Power consumption: 16W
Board material: aluminium core
Surface and color: white

LED-MODUL 230X230 MM 230V/AC 16W 3000K CRI>85 1600LM ALUPCB 60X LED SSC 5630HV WEISS

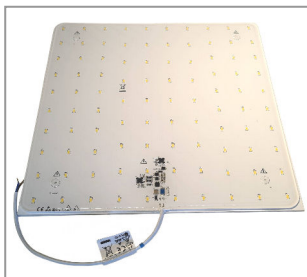

Product number

Width 230mm
Length: 230mm
Screw-on: Yes
Number of poles: 2
CRI: >85
Light output: 1600lm
Power supply: AC - 230V
Color 3.000K
temperature: 3.000K

1201-0230-0230-8300

Material: Aluminium
Power consumption: 16W
Board material: aluminium core
Surface and color: white

LED-MODUL 340X340 MM 230V/AC 36W 3000K CRI>85 3950LM ALUPCB 96X LED SSC 5630HV WEISS

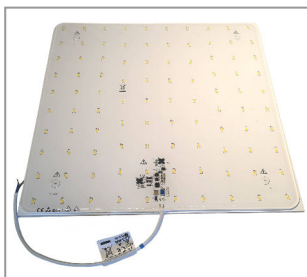

Product number

Width 340mm
Length: 340mm
Number of poles: 2
Light output: 3950lm
Surface: PUR-Polyurethan
CRI: >85
Weight: 1,087kg
Power supply: AC - 230V

1201-0340-0230-8300

Color 3.000K
temperature: 3.000K
Power consumption: 36W
Surface and color: white

LED-MODUL 38,5X11MM 150MA 11-12,2V 2W 270LM 3.000K CRI>90 F. BLACKLINE 2X2



Product number 1300-0038-0150-9300
 Height 11mm
 Width 38.5mm
 Weight: 1,3g
 Light output: 270lm
 Color 3.000K
 temperature:
 CRI: >90

LED-MODUL 38,5X11MM 150MA 11-12,2V 2W 280LM 4.000K CRI>90 F. BLACKLINE 2X2



Product number 1300-0038-0150-9400
 Height 11mm
 Width 38.5mm
 Weight: 1,3g
 Light output: 280lm
 Color 4.000K
 temperature:
 CRI: >90

LED MODULE 70X24 MM MAX. 360MA 3.000K CRI>80

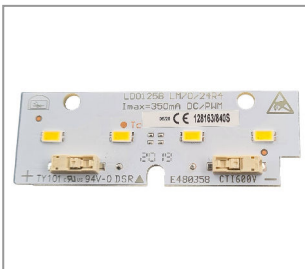

Product number 1300-0070-0360-8300
 Width 24mm
 L?nge: 70mm
 Number of 2
 poles:
 Power supply: CC
 At CC: 360mA
 CRI: >80
 Color 3.000K
 temperature:

LED MODULE 70X24 MM MAX. 360MA 4.000K CRI>80



Product number 1300-0070-0360-8400
 Width 24mm
 L?nge: 70mm
 Number of 2
 poles:
 Power supply: CC
 At CC: 360mA
 CRI: >80
 Color 4.000K
 temperature:

LED-MODUL 70X49 MM F. 1X 2X2 OPTIK @320MA 15W 48V 2355LM MAX.480MA 5000K CRI>80 ALU PCB



Product number
Width 49mm
Länge: 70mm
Screw-on: Yes
Plug contact: Yes
Power supply: CC
At CC: 320mA
CRI: >80
Power consumption: 15W

1300-0070-0480-8500
Color 5.000K
temperature:
Light output: 2355lm
Material: Aluminium
Board material: aluminium core
Weight: 15,4g
Surface and color: white

LED-MODUL 70X49 MM F. 1X 2X2 OPTIK @700MA 8W 12V 1400LM MAX.1500MA 4000K CRI>80 ALU PCB

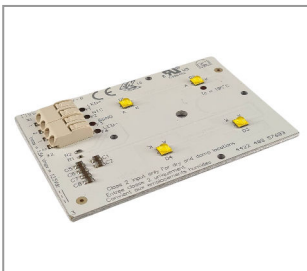

Product number
Width 49mm
Länge: 70mm
Screw-on: Yes
Plug contact: Yes
Power supply: CC
Weight: 15,6g
CRI: >80
Light output: 1400lm

1300-0070-1500-8400
Material: Aluminium
Color 4.000K
temperature:
Power 8W
consumption:
Board material: aluminium core
At CC: 700mA
Surface and color: white

LED-MODUL 92X12MM 150MA 36V 6W 900LM 3.000K CRI>90 F. BLACKLINE M



Product number
Width 12mm
Länge: 92mm
Screw-on: Yes
Solder pad: Yes
Power supply: CC
Light output: 900lm
Color 3.000K
temperature:
Weight: 3,4g

1300-0092-1000-9300
At CC: 150mA
Material: Aluminium
Power 6W
consumption:
Board material: aluminium core
CRI: >90
Surface and color: white

LED-MODUL 95X12MM 150MA 36V 6W 900LM 3.000K CRI>90 F. BLACKLINE S



Product number
Width 12mm
Länge: 95mm
Screw-on: Yes
Solder pad: Yes
Power supply: CC
Light output: 900lm
Material: Stainless steel
Color 3.000K
temperature:

1300-0095-1000-9300
Weight: 3,3g
At CC: 150mA
Power 6W
consumption:
Board material: aluminium core
CRI: >90
Surface and color: white

LED-MODUL 121X49 MM F. 2X 2X2 OPTIK @700MA 16W 24V 2320LM MAX.1500MA 3000K CRI>80 ALU PCB



Product number	1300-0121-1500-8300
Width	49mm
Länge:	121mm
Screw-on:	Yes
Plug contact:	Yes
Light output:	2320lm
Power supply:	CC
CRI:	>80
Weight:	25,5g
Color	3.000K
temperature:	
Material:	Aluminium
Power	16W
consumption:	
Board material:	aluminium core
At CC:	700mA
Surface and color:	white

LED-MODUL 121X49 MM F. 2X 2X2 OPTIK @700MA 16W 24V 2480LM MAX.1500MA 4000K CRI>80 ALU PCB



Product number	1300-0121-1500-8400
Width	49mm
Länge:	121mm
Screw-on:	Yes
Plug contact:	Yes
Power supply:	CC
CRI:	>80
Light output:	2480lm
Weight:	26,1g
Material:	Aluminium
Color	4.000K
temperature:	
Power	16W
consumption:	
Board material:	aluminium core
At CC:	700mA
Surface and color:	white

LED-MODUL 121X49 MM F. 2X 2X2 OPTIK @700MA 16W 24V 2800LM MAX.1500MA 5000K CRI>80 ALU PCB



Product number	1300-0121-1500-8500
Width	49mm
Länge:	121mm
Screw-on:	Yes
Plug contact:	Yes
Light output:	2800lm
Power supply:	CC
CRI:	>80
Weight:	26,1g
Color	5.000K
temperature:	
Material:	Aluminium
Power	16W
consumption:	
Board material:	aluminium core
At CC:	700mA
Surface and color:	white

LED-MODUL 5050 LED'S 145X45 MM F. 1X 2X6 OPTIK @950MA 46W 48V 7360LM MAX.1500MA 5000K CRI>80 ALU PCB



Product number	1300-0145-1440-8500
Width	45mm
Länge:	145mm
Screw-on:	Yes
Plug contact:	Yes
At CC:	960mA
Power	46W
consumption:	
Power supply:	CC
CRI:	>80
Weight:	27,5g
Light output:	7222lm
Color	5.000K
temperature:	
Material:	Aluminium
Board material:	aluminium core
Surface and color:	white

LED-MODUL 3535LED'S 145X45 MM F. 1X 2X6 OPTIK @350MA 12,6W 36V 2050LM MAX.1500MA 5000K CRI>80 ALU PCB



Product number

Width 45mm
 Länge: 145mm
 Screw-on: Yes
 Plug contact: Yes
 Light output: 2050lm
 Power supply: CC
 At CC: 350mA
 CRI: >80

1300-0145-1500-8500

Color 5.000K
 temperature:
 Material: Aluminium
 Board material: aluminium core
 Surface and color: white
 Weight: 27,8g

LED-MODUL 147X45 MM 230V/AC 13W 3000K CRI>85 1300LM 12X LED OSRAM S8 M. LEDIL OPTIK CS14597 HP-IP-2X6-0

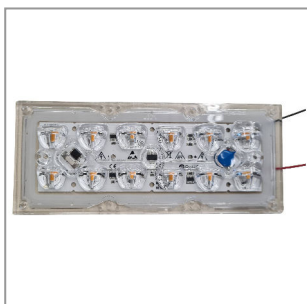

Product number

Width 45mm
 Länge: 147mm
 Number of poles: 2
 CRI: >85
 Light output: 1300lm
 Power consumption: 13W
 Power supply: AC - 230V
 Color 3.000K
 temperature:

1300-0147-0230-8300

LED-MODUL 154X23MM 24V 3000K CRI>90 PASSEND F. BLACKLINE OPTIK U. PROFIL

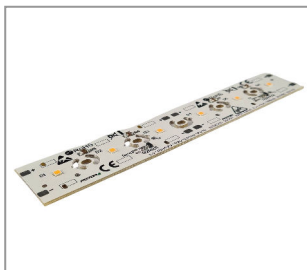

Product number

Height 23mm
 Width 154mm
 Weight: 13,4g
 Color 3.000K
 temperature:
 CRI: >90

1300-0154-0024-9300

LED-MODUL 154X23MM MAX. 400MA 3000K CRI>90 PASSEND F. BLACKLINE L OPTIK U. PROFIL

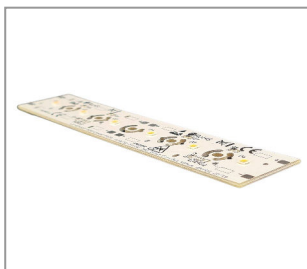

Product number

Width 23mm
 Länge: 154mm
 Number of poles: 2
 Power supply: CC
 Color 3.000K
 temperature:
 At CC: 400mA
 CRI: >90

1300-0154-0400-9300

LED-MODUL 172X49 MM F. 3X 2X2 OPTIK @700MA 24W 36V 3720LM MAX.1500MA 4000K CRI>80 ALU PCB



Product number	1300-0172-1500-8400
Width	49mm
Length:	172mm
Screw-on:	Yes
Plug contact:	Yes
Power supply:	CC
Light output:	3720lm
CRI:	>80
Weight:	36,6g
Power	24W
consumption:	
Material:	Aluminium
Color	4.000K
temperature:	
Board material:	aluminium core
At CC:	700mA
Surface and color:	white

LED-MODUL 172X49 MM F. 3X 2X2 OPTIK @700MA 24W 36V 3720LM MAX.1500MA 5000K CRI>80 ALU PCB



Product number	1300-0172-1500-8500
Width	49mm
Length:	172mm
Screw-on:	Yes
Plug contact:	Yes
Weight:	36,7g
Power supply:	CC
Light output:	3720lm
CRI:	>80
Color	5.000K
temperature:	
Power	24W
consumption:	
Material:	Aluminium
Board material:	aluminium core
At CC:	700mA
Surface and color:	white

LED-MODUL 223X49 MM F. 4X 2X2 OPTIK @700MA 32W 48V 4960LM MAX.1500MA 4000K CRI>80 ALU PCB



Product number	1300-0223-1500-8400
Width	49mm
Length:	233mm
Screw-on:	Yes
Plug contact:	Yes
Power supply:	CC
CRI:	>80
Power	32W
consumption:	
Light output:	4960lm
Weight:	49g
Material:	Aluminium
Color	4.000K
temperature:	
Board material:	aluminium core
At CC:	700mA
Surface and color:	white

LED-MODUL 230X35 MM MAX. 720MA 3000K CRI>85 M. ADELS-KLEMME



Product number	1300-0230-0720-8300
Width	35mm
Length:	230mm
Number of poles:	2
At CC:	720mA
Weight:	26,23g
Power supply:	CC
CRI:	>85
Color	3.000K
temperature:	

LED MODULE 280X24 MM MAX. 360MA 3.000K CRI>80

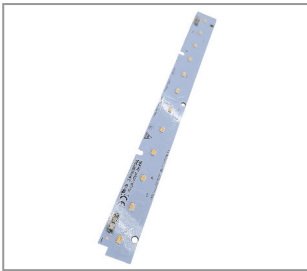

Product number	1300-0280-0360-8300
Width	24mm
Länge:	280mm
Number of poles:	2
Plug contact:	Yes
Board material:	FR4
Power supply:	CC
At CC:	360mA
CRI:	>80

Color	3.000K
temperature:	

LED MODULE 280X24 MM MAX. 360MA 4.000K CRI>80



Product number	1300-0280-0360-8400
Width	24mm
Länge:	280mm
Screw-on:	Yes
Number of poles:	2
Plug contact:	Yes
Board material:	FR4
Power supply:	CC
At CC:	360mA

CRI:	>80
Color	4.000K
temperature:	

LED-MODUL 280X55 MM MAX. 600MA 3000K CRI>80 M. 2X 1POL. SMD KLEMME RÜCKSEITIG



Product number	1300-0280-0480-8301
Width	55mm
Länge:	280mm
Screw-on:	Yes
Number of poles:	2
Plug contact:	Yes
Board material:	FR4
Power supply:	CC
At CC:	480mA

CRI:	>80
Color	3.000K
temperature:	
Weight:	46,48g

LED MODULE 280X55 MM MAX. 600MA 3500K CRI>80 WITH 2X 1-PIN SMD-CLAMP ON THE BACK. SMD TERMINAL AT THE REAR

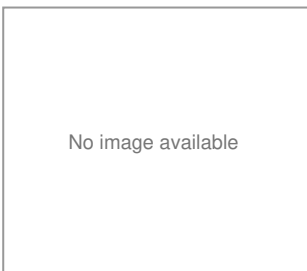

Product number	1300-0280-0480-8351
Width	55mm
Länge:	280mm
Color	3.500K
temperature:	
Channels:	2
CRI:	>80

LED MODULE 280X55 MM MAX. 600MA 4000K CRI>80 WITH 2X 1-PIN SMD-CLAMP ON THE BACK. SMD TERMINAL AT THE REAR

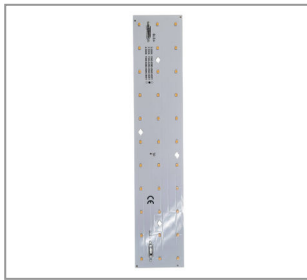

Product number	1300-0280-0480-8401	
Height	7.5mm	Power supply: CC
Width	55mm	At CC: 480mA
Länge:	280mm	CRI: >80
Screw-on:	Yes	beam angle: 120 degrees
Number of poles:	2	Color 4.000K
Channels:	1	temperature:
Plug contact:	Yes	Weight: 51g
Board material:	FR4	Surface and color: white
		IP Schutzart: IP20

LED-MODUL 280X55 MM MAX. 600MA 3000K CRI>90 M. 2X 1POL. SMD KLEMME RÜCKSEITIG

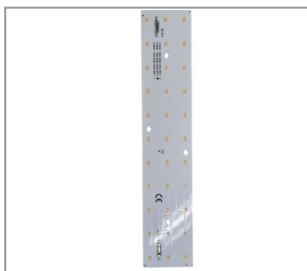

Product number	1300-0280-0480-9301
-----------------------	----------------------------

LED-MODUL 280X55 MM MAX. 540MA 3000K CRI>80 M. 2X 1POL. SMD KLEMME RÜCKSEITIG

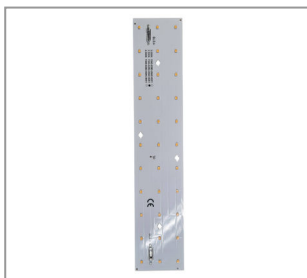

Product number	1300-0280-0540-8301	
Height	7.2mm	Power supply: CC
Width	55mm	At CC: 480mA
Länge:	280mm	CRI: >80
Screw-on:	Yes	beam angle: 120 degrees
Number of poles:	2	Color 3.000K
Channels:	1	temperature:
Plug contact:	Yes	Weight: 51g
Board material:	FR4	Surface and color: white
		IP Schutzart: IP20

LED-MODUL 280X20 MM MAX. 540MA 4000K CRI>85 24X LED OSRAM DURIS E5 M. ADELS-KLEMME



Product number	1300-0280-0540-8400	
Width	20mm	At CC: 540mA
Länge:	280mm	Color 4.000K
Screw-on:	Yes	temperature:
Number of poles:	2	
Plug contact:	Yes	
Board material:	FR4	
Power supply:	CC	
CRI:	>85	

LED MODULE 280X24MM 28X2835LED FOR LEDIL DAISY 7X4 @350MA 40.1V 14W 2.380LM 3.000K CRI>80

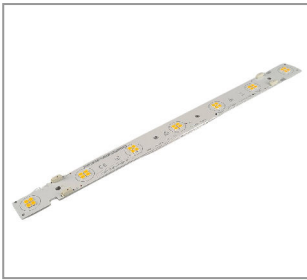

Product number 1300-0280-0614-2883

Width 28mm
 Länge: 280mm
 Light output: 2380lm
 CRI: >80
 Weight: 21,5g
 Color 3.000K
 temperature:
 Material: Aluminium
 Surface and color: white

LED MODULE 280X24MM 28X2835LED FOR LEDIL DAISY 7X4 @350MA 40.1V 14W 2.380LM 3.500K CRI>80



Product number 1300-0280-0614-28835

Width 24mm
 Länge: 280mm
 Light output: 2380lm
 Color 3.500K
 temperature:
 CRI: >80
 Weight: 21,5g
 Material: Aluminium
 Surface and color: white

LED MODULE 280X24MM 28X2835LED FOR LEDIL DAISY 7X4 @350MA 40.1V 14W 2.460LM 4.000K CRI>80



Product number 1300-0280-0614-2884

Width 24mm
 Länge: 280mm
 Light output: 2460lm
 CRI: >80
 Weight: 21,5g
 Material: Aluminium
 Color 4.000K
 temperature:
 Surface and color: white

LED-MODUL 280X20 MM MAX. 640MA 4000K CRI>80



Product number 1300-0280-0640-8400

Width	20mm	At CC:	640mA
Länge:	280mm	Color	4.000K
Screw-on:	Yes	temperature:	
Number of poles:	2		
Plug contact:	Yes		
Board material:	FR4		
Power supply:	CC		
CRI:	>80		

LED-MODUL 318X23MM 17W 24V/DC CRI>90 2700K 4X1POL SMD KLEMME PASSEND F. BLACKLINE L OPTIK U. PROFIL



Product number		1300-0318-1724-9270	
Height	5.7mm	Color	2.700K
Width	29mm	Surface and color:	white
Length	318mm	Material:	Plastic
Screw-on:	Yes	IP Schutzart:	IP20
Channels:	1	Power supply:	CV
Plug contact:	Yes	Light output:	1235lm
Board material:	FR4	At CV:	24
Number of poles:	4	beam angle:	120 degrees
		Power	17W
		consumption:	
		CRI:	>90
		Weight:	29g

LED MODULE 318X23MM 17W 24V/DC CRI>90 2700K 4X1POL SMD TERMINAL SUITABLE FOR BLACKLINE L OPTICS AND PROFILE



Product number	1300-0318-1724-9270R
-----------------------	-----------------------------

LED-MODUL 318X23MM 17W 24V/DC CRI>90 3000K 4X1POL SMD KLEMME PASSEND F. BLACKLINE L OPTIK U. PROFIL



Product number		1300-0318-1724-9300	
Height	5.75mm	Power supply:	CV
Width	29mm	Light output:	1235lm
Length	318mm	At CV:	24
Screw-on:	Yes	Power	17W
Channels:	1	consumption:	
Plug contact:	Yes	Color	3.000K
Board material:	FR4	temperature:	
Number of poles:	4	CRI:	>90
		Weight:	29g
		Surface and color:	white
		IP Schutzart:	IP20

LED MODULE 318X23MM 17W 24V/DC CRI>90 3000K 4X1PIN SMD-CLAMP SUITABLE FOR BLACKLINE L OPTICS AND PROFILE



Product number	1300-0318-1724-9300R
-----------------------	-----------------------------

LED-MODUL 318X23MM 17W 24V/DC CRI>90 4000K 4X1POL SMD KLEMME PASSEND F. BLACKLINE L OPTIK U. PROFIL



Product number	1300-0318-1724-9400		
Width	23mm	Color	4.000K
Length:	318mm	temperature:	
Number of poles:	2	CRI:	>90
Board material:	FR4		
Weight:	28g		
Power supply:	CV		
At CV:	24		
Power consumption:	17W		

LED MODULE 560X24 MM MAX. 360MA 3.000K CRI>80

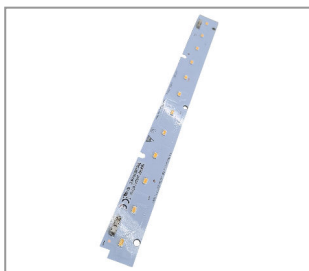

Product number	1300-0560-0360-8300		
Width	24mm	CRI:	>80
Length:	560mm	Color	3.000K
Screw-on:	Yes	temperature:	
Number of poles:	2		
Plug contact:	Yes		
Board material:	FR4		
Power supply:	CC		
At CC:	360mA		

LED-MODUL 560X24 MM MAX. 360MA 4.000K CRI>80

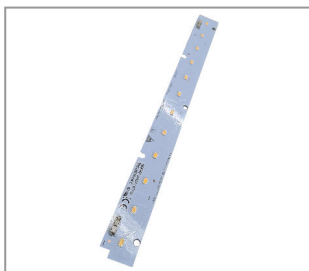

Product number	1300-0560-0360-8400		
Width	24mm	CRI:	>80
Length:	560mm	Color	4.000K
Screw-on:	Yes	temperature:	
Number of poles:	2		
Plug contact:	Yes		
Board material:	FR4		
Power supply:	CC		
At CC:	360mA		

LED-MODUL 560X24 MM MAX. 360MA 4.000K CRI>90



Product number	1300-0560-0360-9400		
Width	24mm	Color	4.000K
Length:	560mm	temperature:	
Screw-on:	Yes	CRI:	>90
Number of poles:	2		
Plug contact:	Yes		
Board material:	FR4		
Power supply:	CC		
At CC:	360mA		

LED-MODUL 280X20 MM MAX. 640MA 4000K CRI>80

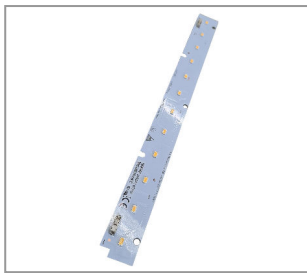

Product number	1300-0560-0640-8400		
Width	20mm	At CC:	640mA
Length:	280mm	Color	4.000K
Screw-on:	Yes	temperature:	
Number of poles:	2		
Plug contact:	Yes		
Board material:	FR4		
Power supply:	CC		
CRI:	>80		

LED-MODUL 3535LED'S 145X45 MM F. 1X 2X6 OPTIK @350MA 12,6W 36V 2050LM MAX.1500MA 5000K CRI>80 ALU PCB M. NTC SENSOR ZUR TEMPERATURKONTROLLE



Product number	1300-1145-1500-8500		
Width	45mm	CRI:	>80
Length:	145mm	Color	5.000K
Screw-on:	Yes	temperature:	
Plug contact:	Yes	Material:	Aluminium
Light output:	2050lm	Board material:	aluminium core
Power supply:	CC	Surface and color:	white
Weight:	28,3g		
At CC:	350mA		

LED MODULE 65X25 MM 230V/AC 8W 3000K CRI>80 CABLE LENGTH 300MM IP54 ALU PCB

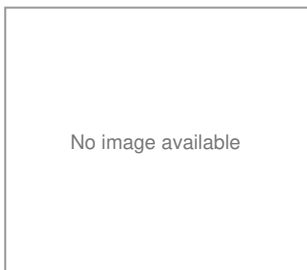

Product number	1301-0065-0230-8300
-----------------------	----------------------------

LED-MODUL 140X30 MM 230V/AC 8W 3000K CRI>85 880LM M. KABEL 130 MM VERGOSSEN

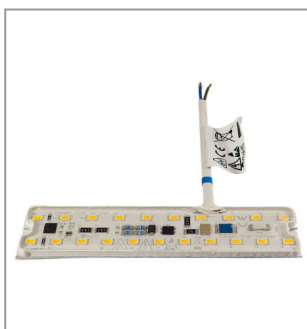

Product number	1301-0140-0230-8300		
Height	8mm	CRI:	>85
Width	30mm	Cable cross section:	0,75mm??
Length:	140mm	beam angle:	120 degrees
Cable length:	130mm	Weight:	45g
Number of poles:	2	Power supply:	AC - 230V
Number of wires:	2	Color	3.000K
Cable conversion:	PVC	temperature:	
Cable end processing:	ferrule	Material:	Aluminium
		IP Schutzart:	IP44
		Power consumption:	8W
		Board material:	aluminium core
		Light output:	800lm
		Cable type:	twin strands
		Surface and color:	white

LED-MODUL 200X130 MM 230V/AC 16W 3000K CRI>85 1600LM ALUPCB 42X LED SSC 5630HV VERGOSSEN WEISS

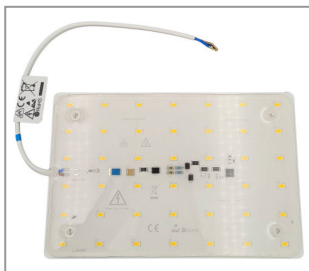

Product number	1301-0200-0230-8300		
Width	200mm	Color	3.000K
Length:	130mm	temperature:	
Screw-on:	Yes	Power	16W
Surface:	PUR-Polyurethan	consumption:	
CRI:	>85	Board material:	aluminium core
Light output:	1600lm		
Power supply:	AC - 230V		
IP Schutzart:	IP68		

LED-MODUL 200X130 MM 230V/AC 8W 3000K CRI>85 880LM ALUPCB VERGOSSEN WEISS



Product number	1301-0200-0230-8301		
Width	130mm	Color	3.000K
Length:	200mm	temperature:	
Number of poles:	2	Power	8W
Light output:	880lm	consumption:	
Surface:	PUR-Polyurethan	Surface and color:	white
CRI:	>85		
Weight:	190g		
Power supply:	AC - 230V		

LED-MODUL 240X170 MM 230V/AC 16W 3000K CRI>85 1780LM ALUPCB WEISS

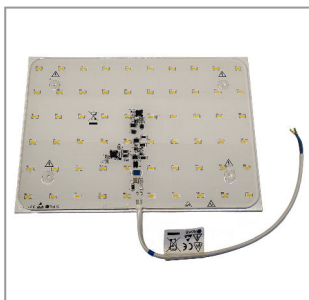

Product number	1301-0240-0230-8300		
Width	170mm	Power	16W
Length:	240mm	consumption:	
Number of poles:	2	Light output:	1780lm
Surface:	PUR-Polyurethan	Surface and color:	white
CRI:	>85		
Power supply:	AC - 230V		
Weight:	229g		
Color	3.000K		
temperature:			

LED-MODUL 240X80 MM 230V/AC 16W 3000K CRI>85 1780LM ALUPCB WEISS

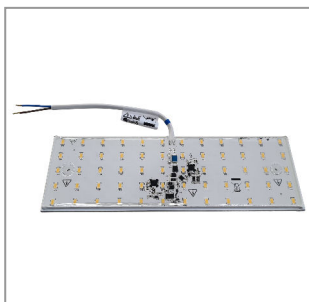

Product number	1301-0240-0230-8301		
Width	80mm	Surface and color:	white
Length:	240mm		
Number of poles:	2		
CRI:	>85		
Power supply:	AC - 230V		
Color	3.000K		
temperature:			
Power	16W		
consumption:			
Light output:	1780lm		

LED MODULE 240X50 MM 230V/AC 16W 3000K CRI>85 1780LM ALUPCB POTTED WHITE L262 CABLE 60 MM LONG LED 2700K

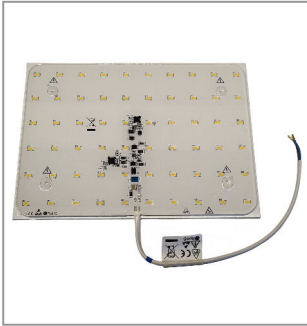

Product number

Height 6mm
Width 50mm
Länge: 240mm
Screw-on: Yes
Number of poles: 2
Channels: 1
Number of wires: 2
Cable conversion: PVC

1301-0240-0230-8302

Surface: PUR-Polyurethan
Cable end processing: ferrule
Cable length: 280mm
Cable cross section: 0,75mm??
beam angle: 120 degrees
Power supply: AC - 230V
Color temperature: 3.000K

Material: Aluminium
IP Schutzart: IP44
Power consumption: 16W
Board material: aluminium core
Light output: 1780lm
Cable type: twin strands
Surface and color: white

LED MODULE 110X20 MM 24V/DC 10.87W 2700K CRI>90 1200LM WITH ERNI-CLAMPS AND PROXYDIMMER CONTROL LED OFF

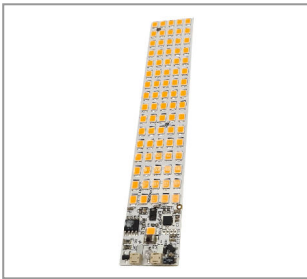

Product number

Width 20mm
Länge: 110mm
Screw-on: Yes
Number of poles: 2
Channels: 1
Color temperature: 2.700K
Power supply: CV
Light output: 1200lm

1320-0110-0024-9270

At CV: 24
Power consumption: 11W
CRI: >90

LED-MODUL 200X7,5 MM TUNEABLE WHITE 24V/DC 4,6W 2200-3000K CRI>90 580LM (2X P066)



Product number

Width 7.5mm
Länge: 200mm
Weight: 4,2g
Material: Aluminium
Light output: 580lm
CRI: >90
Surface and color: white

1320-0200-0024-2751

LED-MODUL 55X38 MM 24V/DC 8,5W 3000K CRI>85 965LM M.TASTER

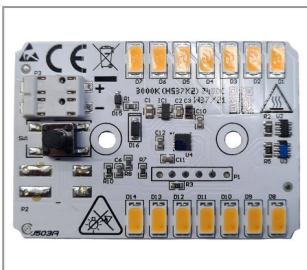

Product number

Height 5mm
Width 38mm
Länge: 55mm
Screw-on: Yes
Light output: 1170lm
Number of poles: 2
Channels: 1
Plug contact: Yes

1360-0055-0024-8300

Board material: FR4
Control: Yes
Power consumption: 9W
Power supply: CV
CRI: >85
Weight: 10g
At CV: 24
beam angle: 120 degrees

Color temperature: 3.000K
Surface and color: white
IP Schutzart: IP20

LED-MODUL 127X60 MM TUNEABLE WHITE 24V/DC 14W 2700-5000K CRI>85 1400LM M. 2 TASTERN

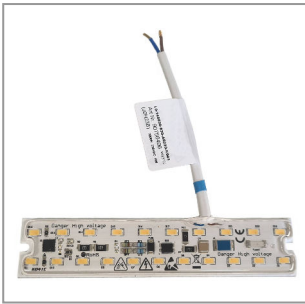

Product number

1360-0127-0024-2750

Width 60mm
 Length: 127mm
 Number of poles: 3
 Color temperature: 2.700K
 Surface: PUR-Polyurethan
 Power supply: CV
 CRI: >85
 At CV: 24

Light output: 1400lm
 Weight: 44,11g
 Power consumption: 14W

LED-MODUL ?? 10 MM MAX.1000MA 2700K CRI>80 1X LED OSLON RACE M. KABEL SCHWARZ U. ROT 600 MM U.LINSE



Product number

Height 7.8mm
 Number of poles: 2
 Channels: 1
 Outer diameter: 10,0mm
 Number of wires: 2
 Cable end processing: tinned
 Power supply: CC
 Color 2.700K
 temperature:

1400-0010-1400-8270

Light output: 400lm
 Surface and color: black
 Cable type: single strand
 CRI: >80
 Cable conversion: FEP
 Cable cross section: 0,34mm??
 Weight: 5g
 Power consumption: 3W

Cable length: 600mm
 At CC: 1400mA
 beam angle: 35 degrees
 Board material: aluminium core
 IP Schutzart: IP20

LED-STERNPLATINE 19,82X20,98 MM MAX. 700MA 254LM 2700K CRI>80 1X LED SZ8-Y19-WW-C8-2/H



Product number

Height 3mm
 Width 19.82mm
 L??nge: 20,98mm
 Number of poles: 2
 Channels: 1
 Solder pad: Yes
 Outer diameter: 21,0mm
 Power supply: CC

1400-0019-0700-8270

Color 2.700K
 temperature: 2700K
 Weight: 1,5g
 Power consumption: 2W
 CRI: >80
 beam angle: 120 degrees
 Light output: 254lm
 Material: Aluminium
 Board material: aluminium core

At CC: 700mA
 Surface and color: white

LED STAR BOARD 20.2X20.2 MM WITH 3M ADHESIVE PAD, MAX. 1,050 MA @700 MA, 2 W 3 V, 280 LM, 3,000 K, CRI>90, WITH CENTERING HOLES FOR OPTICS 21.5X11.8 MM.



Product number

1400-0019-1050-9371

LED STAR BOARD 20.2X20.2 MM MAX. 1,050MA @700MA 2W 3V 280LM 4,000K CRI>90 M-. CENTERING HOLES FOR OPTICS 21.5X11.8



Product number

1400-0019-1050-9471

LED-STERNPLATINE 19,82X20,98 MM MAX. 1.800MA 2.700K CRI>90 INKL. WÄRMELEITPAD U. 2X KABEL SCHWARZ/ROT 1X0,5 750MM LG.



Product number

1400-0019-1800-9270

Height	5mm	Cable end	tinned	Light output:	500lm
Width	19.8mm	processing:		At CC:	1800mA
Länge:	20,98mm	Outer diameter:	21,0mm	Power	4W
Screw-on:	Yes	Power supply:	CC	consumption:	
Number of poles:	2	Color	2.700K	Material:	Aluminium
Channels:	1	temperature:		Board material:	aluminium core
Cable length:	750mm	Weight:	1,5g	CRI:	>90
Number of wires:	2	Cable type:	single strand	Cable cross section:	0,5mm ²
		Cable	FEP	Surface and color:	white
		conversion:		IP Schutzart:	IP20
		beam angle:	120 degrees		

LED MODULE Ø19 MM 24VDC 6W 2700K CRI>90 5X LED WITH CABLE BLACK AND RED 500 MM LONG



Product number

1400-0019-2460-9270

Screw-on:	Yes	CRI:	>90
Solder pad:	Yes	Weight:	5,51g
Outer diameter:	19,0mm	Anzahl Linsen:	7Stk
Color	2.700K		
temperature:			
Linsentyp:	Multilinsen		
Power	6W		
consumption:			
Board material:	aluminium core		
Cable length:	500mm		

LED-MODUL Ø19 MM 24VDC 6W 2700K CRI>90 5X LED M. KABEL SCHWARZ U. ROT 500 MM LANG

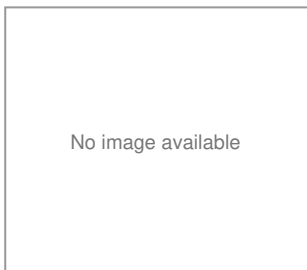

Product number

1400-0019-2460-9270R

LED-STERNPLATINE 19,82X20,98 MM MAX. 3000MA 3.000K CRI90 1X LED CREE XLAMP XP-L2 2 STEP SDCM



Product number

1400-0019-3000-9300

Height	5mm	Weight:	5g
Screw-on:	Yes	At CC:	3000mA
Number of poles:	2	Color	3.000K
Channels:	1	temperature:	
Solder pad:	Yes	Material:	Aluminium
Power supply:	CC	Board material:	aluminium core
Outer diameter:	20,98mm	CRI:	>90
beam angle:	120 degrees	Surface and color:	white
		IP Schutzart:	IP20

LED-MODUL 50X7 MM MAX. 700MA 2700K CRI>90

Product number

Height 4mm
 Width 7mm
 Length: 50mm
 Screw-on: Yes
 Number of poles: 2
 Channels: 1
 Solder pad: Yes
 Power supply: CC

1400-0050-0700-9270

Color 2.700K IP Schutzart: IP20
 temperature: 120 degrees
 beam angle: 120 degrees
 Weight: 5g
 Light output: 700lm
 Power consumption: 6W
 Board material: aluminium core
 CRI: >90
 At CC: 700mA

LED-MODUL 290 MM 8KT. 24V/DC 24,9W 3000K CRI>85 2105LM 64X LED OSRAM DURIS P5



Product number	1600-0290-0024-8301		
Height	290mm	Surface:	Painted
Screw-on:	Yes	Outer diameter:	80,0mm
Channels:	1	Power supply:	CV
Plug contact:	Yes	CRI:	>85
Number of poles:	4	Power consumption:	25W
Control:	Yes	At CV:	24
beam angle:	360 degrees	Color	3.000K
Weight:	150g	temperature:	
		Material:	Aluminium
		IP Schutzart:	IP44
		Board material:	aluminium core
		Light output:	3250lm
		Surface and color:	white

LED MODULE 290 MM 12CT. 24V/DC 51.2W 3000K CRI>85 4139LM 96X LED OSRAM DURIS P5



Product number	1600-0290-0024-8302		
Height	290mm	Surface:	Painted
Width	85mm	Light output:	4200lm
Länge:	85mm	Power supply:	CV
Channels:	1	CRI:	>85
Plug contact:	Yes	At CV:	24
Number of poles:	4	Color	3.000K
Control:	Yes	temperature:	
beam angle:	360 degrees	Weight:	267g
		Power consumption:	52W
		Material:	Aluminium
		Board material:	aluminium core
		Surface and color:	white
		IP Schutzart:	IP20

LED MODULE 180X150 MM 230V/AC 16W 3000K CRI>85 1600LM ALUPCB 63X LED SSC POTTED WITH CABLE 300 MM WHITE

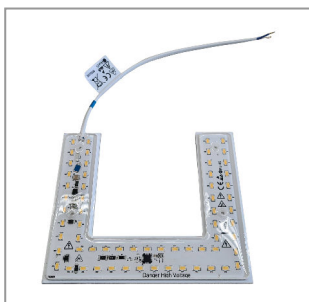

Product number	1601-0181-0230-8300		
Height	6mm	Surface:	PUR-Polyurethan
Width	150mm	Cable end processing:	ferrule
Länge:	180mm	CRI:	>85
Screw-on:	Yes	Light output:	1600lm
Number of poles:	2	Cable length:	280mm
Channels:	1	beam angle:	120 degrees
Number of wires:	2	Power supply:	AC - 230V
Cable conversion:	PVC	Color	3.000K
		temperature:	
		Material:	Aluminium
		IP Schutzart:	IP44
		Power consumption:	16W
		Board material:	aluminium core
		Cable type:	twin strands
		Surface and color:	white

LED-MODUL 180X150 MM 230V/AC 16W 4000K CRI>85 1600LM ALUPCB 63X LED SSC VERGOSSEN M. KABEL 300 MM WEISS

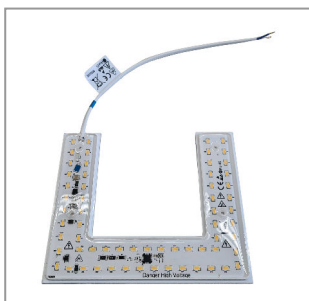

Product number	1601-0181-0230-8400		
Height	8mm	Surface:	PUR-Polyurethan
Width	150mm	Cable end processing:	ferrule
Länge:	180mm	CRI:	>85
Screw-on:	Yes	Light output:	1600lm
Number of poles:	2	Cable length:	280mm
Channels:	1	Cable cross section:	0,75mm??
Number of wires:	2	beam angle:	120 degrees
Cable conversion:	PVC	Power supply:	AC - 230V
		Material:	Aluminium
		IP Schutzart:	IP44
		Color	4.000K
		temperature:	
		Power consumption:	16W
		Board material:	aluminium core
		Weight:	210g
		Cable type:	twin strands
		Surface and color:	white

LED MODUL 146X30MM F. BLACKLINE XL Ø400 @100MA 3,6W 34V 500LM MAX. BESTROMUNG 160MA 3000K CRI>90 8 MODULE WERDEN FÜR EINEN GESCHLOSSENEN RING BENÖTIGT

**Product number**

Width 30mm
 Länge: 146mm
 Screw-on: Yes
 Solder pad: Yes
 At CC: 100mA
 Power supply: CC
 Weight: 6,6g
 Light output: 500lm

1620-0146-0160-9300

Color 3.000K
 temperature:
 Material: Aluminium
 Board material: aluminium core
 CRI: >90
 Surface and color: white

LED MODUL 148X30MM F. BLACKLINE XL Ø600 @100MA 3,6W 34V 500LM MAX. BESTROMUNG 160MA 3000K CRI>90 12 MODULE WERDEN FÜR EINEN GESCHLOSSENEN RING BENÖTIGT

**Product number**

Width 30mm
 Länge: 148mm
 Screw-on: Yes
 Solder pad: Yes
 Power supply: CC
 Weight: 6,7g
 Light output: 500lm
 Color 3.000K
 temperature:

1620-0148-0160-9300

At CC: 160mA
 Material: Aluminium
 Board material: aluminium core
 CRI: >90
 Surface and color: white

LED MODUL 175X30MM F. BLACKLINE XL Ø800 @100MA 3,6W 34V 500LM MAX. BESTROMUNG 160MA 3000K CRI>90 15 MODULE WERDEN FÜR EINEN GESCHLOSSENEN RING BENÖTIGT

**Product number**

Width 30mm
 Länge: 175mm
 Screw-on: Yes
 Solder pad: Yes
 At CC: 100mA
 Power supply: CC
 Weight: 9,7g
 Light output: 500lm

1620-0175-0160-9300

Color 3.000K
 temperature:
 Material: Aluminium
 Board material: aluminium core
 CRI: >90
 Surface and color: white

LED MODUL 182,5X27,5MM F. BLACKLINE XL Ø1500 @100MA 3,6W 34V 500LM MAX. BESTROMUNG 160MA 3000K CRI>90 24 MODULE WERDEN FÜR EINEN GESCHLOSSENEN RING BENÖTIGT

**Product number**

Width 27.5mm
 Länge: 182,5mm
 Screw-on: Yes
 Solder pad: Yes
 At CC: 100mA
 Power supply: CC
 Light output: 500lm
 Weight: 11,3g

1620-0182-0160-9300

Color 3.000K
 temperature:
 Material: Aluminium
 Board material: aluminium core
 CRI: >90
 Surface and color: white

LED MODUL 175X28MM F. BLACKLINE XL Ø1200 @100MA 3,6W 34V 500LM MAX. BESTROMUNG 160MA 3000K CRI>90 20 MODULE WERDEN FÜR EINEN GESCHLOSSENEN RING BENÖTIGT



Product number

Width 28mm
Länge: 175mm
Screw-on: Yes
Solder pad: Yes
At CC: 100mA
Power supply: CC
Light output: 500lm
Color 3.000K
temperature:

1620-1175-0160-9300

Material: Aluminium
Weight: 10,8g
Board material: aluminium core
CRI: >90
Surface and color: white

LED MODUL 175X25MM F. BLACKLINE XL Ø1800 @100MA 3,6W 34V 500LM MAX. BESTROMUNG 160MA 3000K CRI>90 30 MODULE WERDEN FÜR EINEN GESCHLOSSENEN RING BENÖTIGT



Product number

Width 25mm
Länge: 175mm
Screw-on: Yes
Solder pad: Yes
At CC: 100mA
Light output: 500lm
Weight: 10,5g
Color 3.000K
temperature:

1620-2175-0160-9300

Material: Aluminium
Board material: aluminium core
CRI: >90
Surface and color: white

LED-MODUL Ø100MM F. SPIEGEL M. LED KRANZ TASTDIMMER U. MIKRO USB 260LM 2700K U. 5000K CRI>90 F. BATTERIEBETRIEB



Product number

Height 7.2mm
Screw-on: Yes
Number of poles: 2
Board material: FR4
Control: Yes
Plug: Yes
Channels: 2
Outer diameter: 100,0mm

1665-0100-0005-9275

Color 2.700K
temperature: 21g
Weight: 21g
Power supply: CV
beam angle: 180 degrees
Material: Aluminium
CRI: >90
Surface and color: white
At CV: 12

IP Schutzart: IP20

LED MODULE Ø100MM FOR MIRROR WITH LED RING, TOUCH DIMMER AND USB-C, 260LM, 2700K AND 5000K, CRI>90, BATTERY-OPERATED

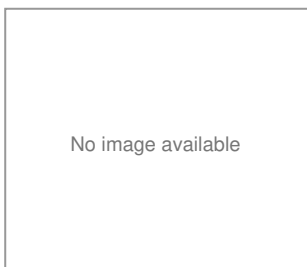

Product number

1665-0100-0005-9275-C